

Mosquito Trap

BG - Mosquitaire

Instruction Manual

2

EN

Updates for the manual can be found on the website: us.biogents.com

Status: June 2019

BG-Mosquitaire™

Safety Instructions and Warnings

- Carefully read the directions for use before you begin operating the BG-Mosquitaire.
- The BG-Mosquitaire catches tiger mosquitoes considerably well; however, it offers less protection against other bloodsucking insects. In case of an epidemic that is caused by tiger mosquitoes, you should take further protective measures since using the trap alone does not offer 100% protection.
- For the maintenance of the BG-Mosquitaire trap and the monitoring of the mosquito catch rate, household gloves should be worn and the catch bag should be properly removed to avoid mosquitoes from escaping.
- **WARNING:** An electric shock hazard may exist if water from a garden hose is directed at the insect trap.
- When using extension cords, please keep the socket-outlet away from any moisture and avoid damage to the cord.
- The appliance is not to be used in or around locations where flammable vapour or explosive dust is likely to exist.
- This appliance is not intended for use by persons (including children) with reduced physical, sensory, or mental capabilities, or lack of experience and knowledge, unless they were given supervision or instruction concerning the use of the appliance by a person that is responsible for their safety.
- Children should be supervised to ensure that they do not play with the appliance.
- The BG-Mosquitaire trap and the BG-Sweetscent dispenser are to be kept out of reach of children.
- Only use accessories and spare parts that are recommended by the manufacturer. The use of other attractants, nets, or gauze with the trap can significantly reduce the catch rate or even completely render it ineffective.
- Only allow qualified specialists with original parts to repair the BG-Mosquitaire trap.
- The power supply and its flexible cable cannot be repaired. If it is damaged, it must be replaced.

Appropriate Uses and Regulations

The BG-Mosquitaire is designed to capture tiger mosquitoes outside as well as inside the house. It needs to be protected from rain and direct sun exposure and should be placed in an area where it will not be submerged in water. The trap and the transformer need to be protected from intense heat (above 104° F / 40° C) and extreme cold (below 23° F / 5° C).

The BG-Mosquitaire should also not be used in very dusty surroundings as the dust may clog the nets and the gauze covering which obstructs the air currents. The manufacturer is not held liable, in any case, if the product is improperly used or if any modifications are made to the product. Please pay close attention to all of the information contained in the instruction manual.

Contents

- 1. Suction funnel with shutter
 - 2. Funnel net
 - 3. Catch bag (2x)
- Preassembled body
- 4. Gauze covering
 - 5. Top part of lid
 - 6. Bottom part of lid
 - 7. Trap body
 - 8. Inner tube with ventilator
- 9. 12 V outdoor power supply (US version with 39 in cable)
 - 10. DC extension cable (33 ft)
 - 11. Mosquito attractant BG-Sweetscent™
(to be ordered separately)

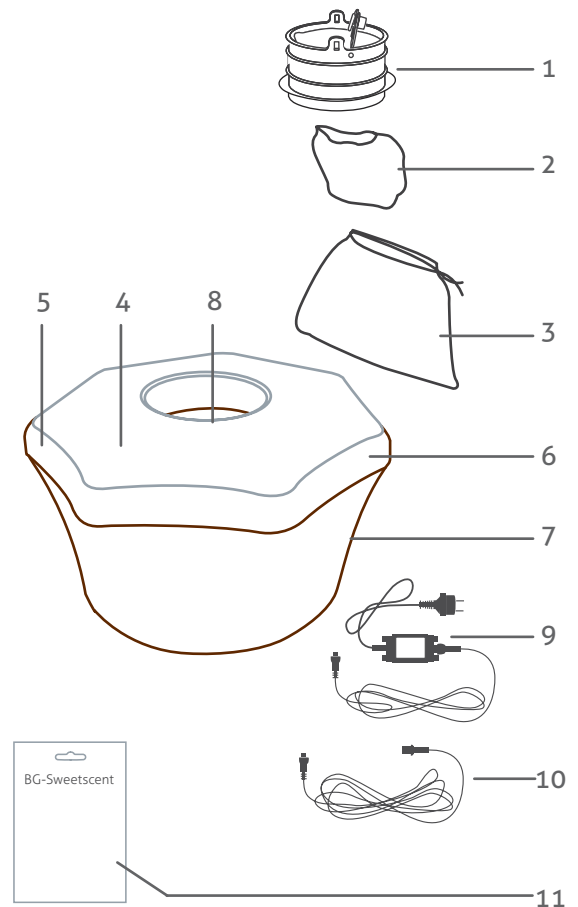

Assembling the Trap

1. Open the BG-Sweetscent package and remove the white BG-Sweetscent pouch [F1]. Place the BG-Sweetscent into the black slot located on the inside wall of the inner tube [F2].
2. Place the funnel net (2) around the bottom of the suction funnel (1) [F3]. Then place the catch bag (3) over the funnel net (2). Tighten the top part of the catch bag (3) about 3/4 in below the top of the funnel net (2) [F4]. Please note the orientation: The two eyelets on the funnel must point upwards [see red arrow, F4].
3. Insert the suction funnel with the attached funnel net and catch bag [F4] into the opening on top of the lid [F5]. Please note the orientation: The two eyelets on the funnel must point upwards (see red arrow, [F4, F5b]).
4. Plug the outdoor power transformer (9) into a water safe outlet [F6]. Use the extension cord to set the trap at distances up to 33 ft from the power transformer. When the power is turned on, the shutter will automatically tilt open.

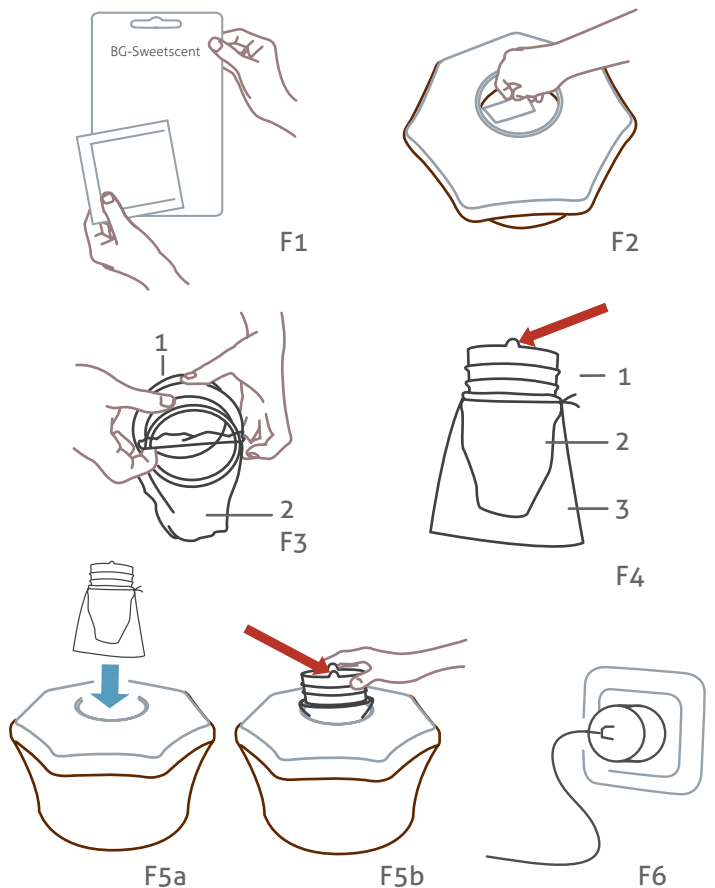

Positioning the Trap: When and Where?

Correct positioning and application are important factors for effective mosquito control

Only if the traps have the correct positioning and run continuously throughout the mosquito season, they will efficiently and permanently decrease the mosquito population. A detailed description of how to best position the trap can be found on our website at: <https://www.biogents-usa.com/wp-content/uploads/Placement-and-effect-of-Biogents-mosquito-traps-en.pdf>

General:

The trap should be placed outside from spring to fall: average temperature > 60° F / 15° C.

Position the trap in a location that **is sheltered from direct sunlight, wind, and heavy rainfall** [F7].

For best results position the trap in **a shady, humid location close to mosquito breeding spots or resting zones** [F8], e.g., in shrubs or under trees, near puddles or rain barrels. The trap will not be affected by rainfall.



No sun

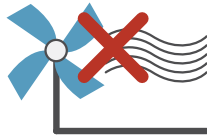

No wind



Shade

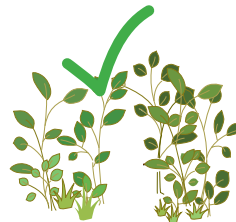

Resting areas



Humidity and breeding areas

F7

F8

In detail:

When?

The trap should be put out when the average temperature has risen above 60° F / 15° C. Above this temperature, adult mosquitoes fly actively. It is best to catch the mosquitoes as early in the year as possible before they have a chance to reproduce and lay their eggs. It is important to make sure that the ventilator of the trap runs 24 hours a day.

Where?

The goal is to catch the mosquitoes before they reach you. Therefore, it is important to choose a position near the resting areas and breeding locations of the mosquitoes.

Good locations

1. **Resting locations:** During the day, mosquitoes spend their rest periods in shady, wind-protected places such as in foliage, e.g., hedges and shrubs. From here, mosquitoes begin their search for prey. If you place the trap here, you can catch the mosquitoes before they reach and bite you. Resting places of mosquitoes can also be locations with higher humidity such as wells, drains, basements, etc. They also like piles of wood where they can easily hide.

Overhanging plants and bushes often form an empty space underneath. This is an ideal location for the trap if it provides enough space both for the air currents and for the visibility of the trap: All of the upper surfaces of the trap must be clearly visible to the mosquito so that its specialized appearance is effective in attracting mosquitoes. Therefore, do not place the trap under very dense bushes [F9]. A distance of at least 1 ft above the top of the trap needs to be kept clear [F10].



F9



F10

1. **Breeding sites:** Mosquitoes lay their eggs in natural and man-made containers. Possible breeding sites could be: Rain barrels, saucers under outdoor plants, black corrugated downspout extensions, and unused buckets, pots and other containers around garden sheds. Placing a trap near larval habitats can be effective; however, always take care of choosing a position that is protected from the sun and wind!

To protect your pets from mosquitoes, don't place the trap directly next to outdoor shelters, but 8-10 ft away.

Heavy rain might reduce the catch rates. Therefore, use a sheltered position, e.g., in a sparse shrub [F10] or under a tree. If you do not find a naturally sheltered position for the trap, it would be best to position the trap under a roofed area or a self-made shelter to keep it out of direct rainfall.

Bad locations

1. **Direct sunlight** (mosquitoes avoid the sun).
2. **Windy spaces** (winds deter the mosquitoes and affect the suction from the ventilator).

The graphic below [F11] depicts good and bad locations for the BG-Mosquitare between mosquito breeding spots, mosquito resting areas, and the house. Please position the trap so that no one can trip over the power cord.

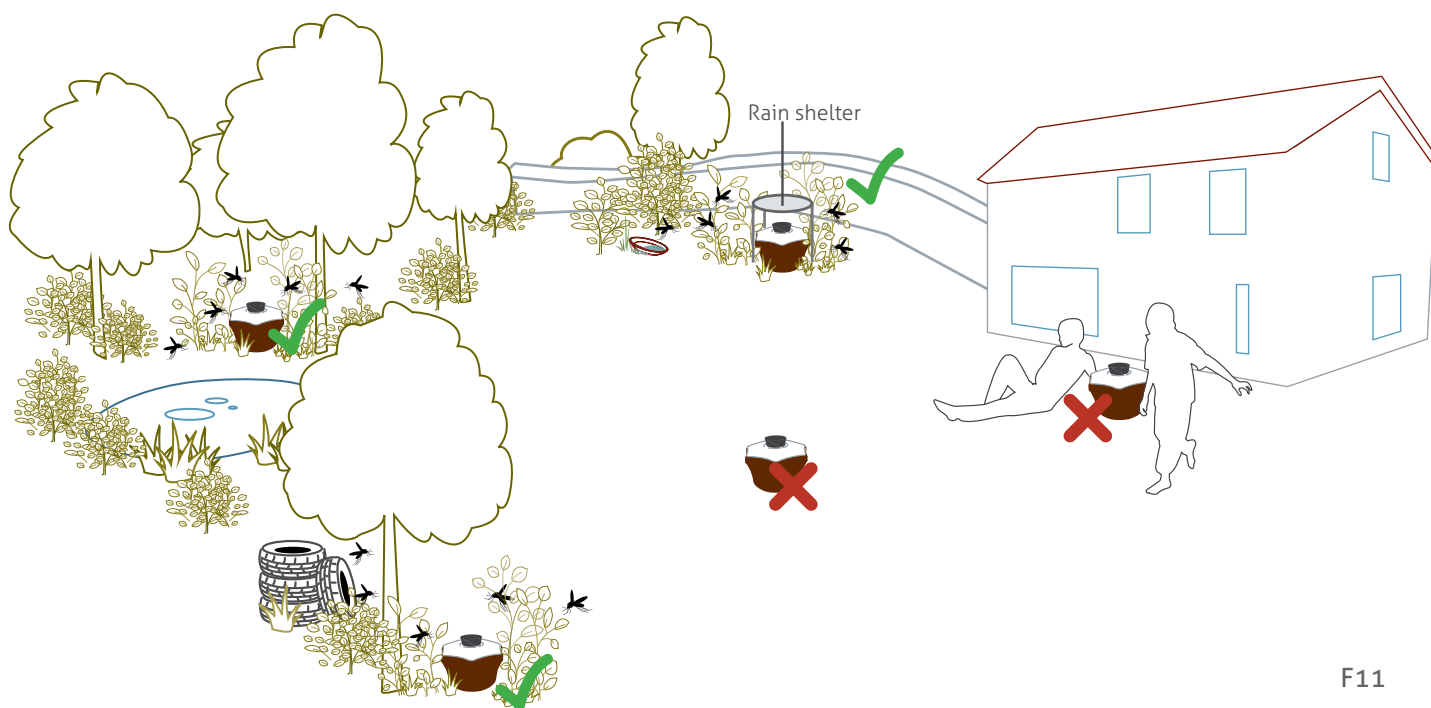

F11

Monitoring the Catch Results

Check the catch bag and obtain the catch results after three days of running the trap. You need to extend the period between checks if it has frequently rained. Reason is that mosquitoes do not fly during rain. Also extend it in spring or fall when the average temperature is below 68° F / 20° C.

Evaluating the catch results: Place the properly removed

catch bag in a freezer bag and store it in a freezer for 2-3 hours to kill the mosquitoes, or simply leave them out in the sun to dehydrate. You can then empty out the contents of the catch bag and count the captured mosquitoes. It is recommended to check the catch success of the trap to make any necessary changes of the trap location.

Maintenance and Care

When working with the BG-Mosquitaire trap and also when monitoring the catch results, household gloves should be worn, and the catch bag should be properly removed. This is to ensure the captured mosquitoes that are still alive cannot escape and cannot bite you through the net.

Use a damp cloth to clean the plastic part of the trap. Do not use any cleaning agents, solvents, or insecticides, because

the residues from these products can have a repelling effect on mosquitoes and consequently reduce the catch rate of the trap. Do not use any pointed or rough objects to clean the trap. Only use recommended accessories and parts from the manufacturer. The use of foreign parts can significantly reduce the catch rate of the BG-Mosquitaire trap or even render it ineffective.

Changing the Catch Bag

The catch bag, along with the caught mosquitoes, should be emptied when it is halfway full. At a minimum the catch bag should be changed when the BG-Sweetscent attractant is replaced. It is important to change the catch bag, because it can become clogged with dust over time and decrease the catch rate of the BG-Mosquitaire.

1. Pull the black suction funnel (1) with the catch bag halfway out of the trap.
2. Pull the catch bag off (3) of the black intake funnel and simultaneously pull the cord shut to close the catch bag [F12].
3. You can now empty the catch bag or evaluate what you caught.
4. Remove the funnel net (2) from the black suction funnel and rinse with warm water to remove the dust. After emptying the catch bag, it can also be cleaned with warm water.
5. Replace the funnel net and catch bag onto the suction funnel and place it back into the trap [F4-5].

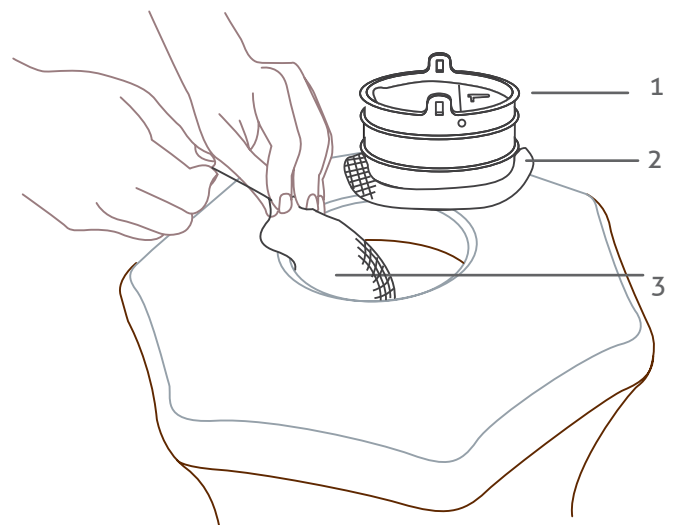

Why is the BG - Sweetscent Important?

The development of the patented BG-Sweetscent is a result of over 16 years of mosquito research at the University of Reensburg in Germany. It is comprised of three components that are found on the human skin and imitates the scent of a human body for the mosquitoes. The BG-Sweetscent enhances the catch rate of the BG-Mosquitaire trap specifically for tiger mosquitoes.

After opening the package, the BG-Sweetscent can be used for roughly eight weeks. After the eight weeks, the BG-Sweetscent must be replaced to ensure the effectiveness of the BG-Mosquitaire trap.

BG - Sweetscent™

Net Contents: 0.39 oz. (11.1 grams). Contains 1 sachet.
EPA Reg. No.: 87472 - 1

BG-Sweetscent – Mosquito Attractant

Mimics naturally occurring human skin scents.

Active ingredients:

Lactic acid	34.59%
Ammonium bicarbonate	26.49%
Hexanoic acid	8.82%
Other ingredients:	30.10%
Total:	100.00%

KEEP OUT OF REACH OF CHILDREN CAUTION

FIRST AID	
If in eyes	<ul style="list-style-type: none"> • Hold eye open and rinse slowly and gently with water for 15 - 20 minutes. • Remove contact lenses, if present, after the first 5 minutes, then continue rinsing eye. • Call a poison control center or doctor for treatment advice.
If on skin or clothing	<ul style="list-style-type: none"> • Take off contaminated clothing. • Rinse skin immediately with plenty of water for 15 - 20 minutes. • Call a poison control center or doctor for treatment advice.
If swallowed	<ul style="list-style-type: none"> • Call poison control center or doctor immediately for treatment advice. • Have person sip a glass of water if able to swallow. • Do not induce vomiting unless told to do so by the poison control center or doctor. • Do not give anything by mouth to an unconscious person.
<p>Have the product container or label with you when calling a poison control center or doctor, or going for treatment. In the U.S. you may also contact 1-800-222-1222 for emergency medical treatment information.</p>	

PRECAUTIONARY STATEMENTS

Hazards to Humans and Domestic Animals - CAUTION:

May cause severe eye irritation. Do not get in eyes, on skin, or on clothing. Harmful if swallowed. Avoid contact of mouth, skin, or eyes with the contents. Wash hands before eating, drinking, chewing gum, using tobacco, or using bathroom facilities.

Environmental Hazards: To protect the environment, do not allow pesticide to enter or run off into storm drains, drainage ditches, gutters, or surface waters. Applying this product in calm weather when rain is not predicted for the next 24 hours will help to ensure that wind or rain does not blow or wash pesticide off the treatment area. Sweeping any product that lands on a driveway, sidewalk, or street, back onto the treated area of the lawn or garden will help to prevent run off to water bodies or drainage systems.

DIRECTIONS FOR USE

It is a violation of Federal law to use this product in a manner inconsistent with its labeling. **DO NOT OPEN SACHET.** BG-Sweetscent is a lure designed to mimic human skin scents to attract mosquitoes to traps where they die. The BG-Sweetscent can be used in any kind of mosquito traps either inside or outside depending on the trap type. Remove the sachet from the transparent plastic bag before use. Place the BG-Sweetscent sachet in the space allocated for added mosquito attractants either inside or outside the trap. Refer to the trap manufacturer's directions for use for placement. Replace the lure after eight (8) weeks of use.

STORAGE AND DISPOSAL

Do not contaminate water, food, or feed by storage and disposal.

Pesticide Storage: Store in a cool, dry place out of reach of children until ready to use. **Pesticide Disposal and Container Handling:** Nonrefillable container. Do not reuse or refill this container. Dispose of used sachet in the trash.

Technical Data

Weight: 2.2 kg
Dimension: 30 x 37 cm
Ventilator: 12 V DC, 3.6 W
Switching power supply: AC Input 100 – 230 V,
Frequency 60 Hz/50 Hz,
DC Output 12 V 1A

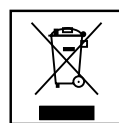

ROHS[✓] CE

EC Declaration of Conformity

Product type: Mosquito trap
Product: BG-Mosquitaire™

The undersigned hereby declares on behalf of Biogents AG, Regensburg, Germany, that the above referenced product to which this declaration relates is in conformity with the provisions of:

- DIRECTIVE 2003/108/EC OF THE EUROPEAN PARLIAMENT AND OF THE COUNCIL of 8 December 2003 amending Directive 2002/96/EC on waste electrical and electronic equipment (WEEE);
- DIRECTIVE 2004/108/EC OF THE EUROPEAN PARLIAMENT AND OF THE COUNCIL of 15 December 2004 on the approximation of the laws of the Member States relating to electromagnetic compatibility;
- DIRECTIVE 2005/88/EC OF THE EUROPEAN PARLIAMENT AND OF THE COUNCIL of 14 December 2005 amending Directive 2000/14/EC on the approximation of the laws of the Member States relating to the noise emission in the environment by equipment for use outdoors;
- DIRECTIVE 2006/42/EC OF THE EUROPEAN PARLIAMENT AND OF THE COUNCIL of 17 May 2006 on machinery, and amending Directive 95/16/EC;
- DIRECTIVE 2006/95/EC OF THE EUROPEAN PARLIAMENT AND OF THE COUNCIL of 12 December 2006 on the harmonisation of the laws of Member States relating to electrical equipment designed for use within certain voltage limits;
- Directive 2008/35/EC of the European Parliament and of the Council of 11 March 2008 amending Directive 2002/95/EC on the restriction of the use of certain hazardous substances in electrical and electronic equipment as regards the implementing powers conferred on the Commission;
- DIRECTIVE 2009/125/EC OF THE EUROPEAN PARLIAMENT AND OF THE COUNCIL of 21 October 2009 establishing a framework for the setting of ecodesign requirements for energy-related products (recast).

The Technical Construction File required by this Directive is maintained at the corporate headquarters of Biogents AG, Weißenburgstr. 22 , 93055 Regensburg, Germany.

Regensburg, December 18, 2017

Handwritten signature of Andreas Rose in black ink.

Andreas Rose
(Director)

Handwritten signature of Martin Geier in black ink.

Martin Geier
(Director)

Biogents AG
Weißenburgstr. 22
93055 Regensburg
Germany
info@biogents.com