



# Pigeon Spike Stainless™

All Stainless Steel, All American Made Bird Deterrent Spike for Pigeons

Pigeon Spike Stainless is an economical, all stainless steel bird spike designed to deter pigeons and seagulls on all types of surfaces, in light infestation levels. No plastic or composites are used in its construction. It can be installed on all types of surface shapes and materials. Optional installation accessories are available (see below).

Pigeon Spike Stainless strips come 2 or 4 foot long and have spring-tempered stainless wires fastened to a flexible 1/4" wide stainless base strip. There are 24 points per foot that cover up to 7" of installation surface. Not designed to deter small birds or heavy infestations of any bird. For total control use Premium Nixalite® Bird Spikes.

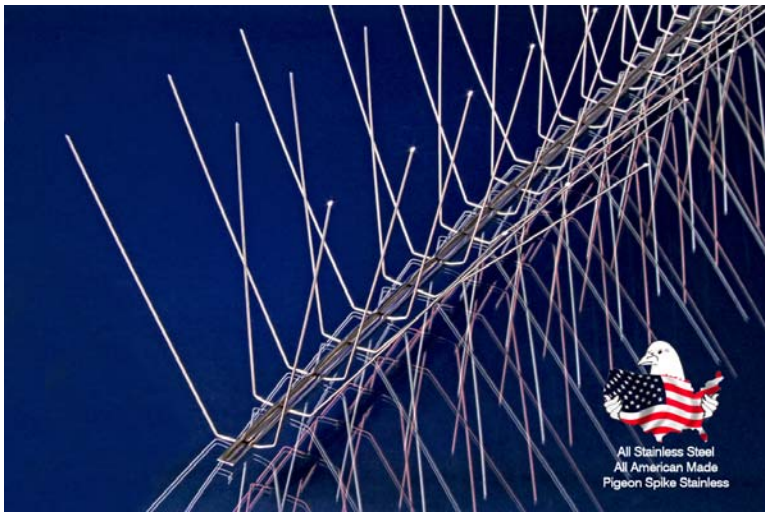

## Pigeon Spike Stainless

- All stainless steel wire & strip
- 6" wide, 4" high, 24 points/ft
- Light pigeon infestation levels
- Pointed or **Blunt Tip** wires
- Available in **ColorCoat** colors

No plastic or composite components are used in the construction of Pigeon Spike Stainless. Fastens to all types of surfaces with the **optional installation accessories**.

## Optional Installation Accessories:

Purchased separately! Nixalite's bird spike strip installation accessories help fasten bird spikes to all types of surfaces.



**ColorCoat:** white, black, gray, tan, brown, bronze. Call for prices.

**Blunt Tip:** puts flat point on wires. Use **ONLY** when human contact is likely, use pointed for all other applications. No cost option.

## Estimating for Pigeon Spike Stainless™

### Basic Estimating Steps:

1. Measure surface **depth** and **length**.
2. Is surface **Single** or **Double Exposed**?
3. Use tables to find the **Rows Required**.
4. **Rows Required X Length = Total**.

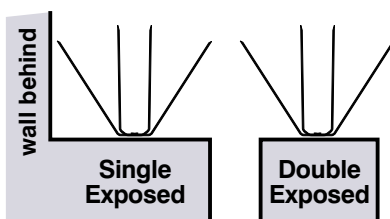

Single Exposed		
Surface Depth		Rows Required
Inches	Centimeters	
0 - 3	0 - 7.6	0*
3 - 7	7.6 - 17.8	1
7 - 14	17.8 - 35.6	2
14 - 21	35.6 - 53.3	3
21 - 28	53.3 - 71.1	4
28 - 35	71.1 - 88.9	5
35 - 42	88.9 - 106.7	6
For each additional 7" add 1 row		

Double Exposed		
Surface Depth		Rows Required
Inches	Centimeters	
0 - 6	0 - 15.2	1
6 - 13	15.2 - 33.0	2
13 - 20	33.0 - 50.8	3
20 - 27	50.8 - 68.6	4
27 - 34	68.6 - 86.4	5
34 - 41	86.4 - 104.1	6
41 - 48	104.1 - 121.9	7
For each additional 7" add 1 row		

\*Too narrow for PSS. Use E-Spike or Premium Nixalite models on narrow surfaces.

# Pigeon Spike Stainless™ Row Spacing

## Spacing Pigeon Spike Stainless™ Bird Spikes

- A - 3" max. to edges
- B - 4" max. to walls
- C - 7" max. between

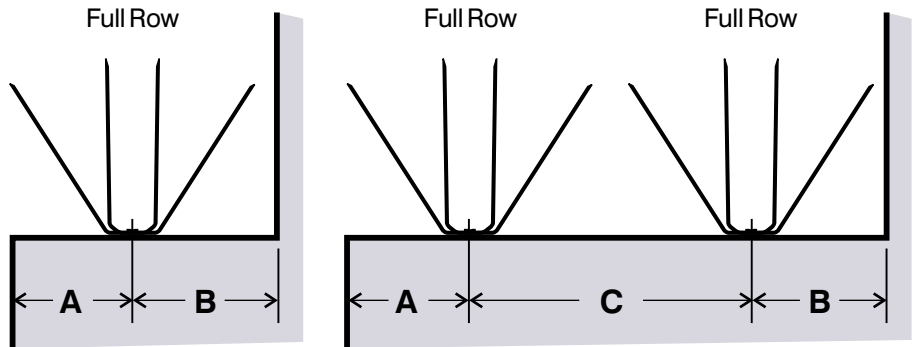

## Installing Pigeon Spike Stainless™

Pigeon Spike Stainless is designed as a deterrent for **pigeons** and **seagulls**. Do not use for small birds or heavy infestations of any bird. For control under all conditions, install the **Nixalite® Premium All Stainless Steel Bird Spike models**.

### Prepare the surface

Clean the surface thoroughly. It must be clean, dry and free of bird waste. Repair any damaged sections of the installation surface.

### Lay out the spike strip positions

Use the **Estimating** and **Spacing** information to determine where on the surface each spike strip will be installed. Mark each spike strip location.

### Fit the strip before fastening

Make sure each spike strip fits the surface properly before fastening it. **Follow these important details when installing:**

Make sure that the spike strips **overhang the ends of the surface at least 1/2"**.

Make sure the **wires** of the strips overhang or are flush with the edge of the surface.

**Do not allow gaps** where two strips meet end-to-end **OR** where spike strips meet a wall or object.

### Fastening Pigeon Spike Stainless Strips

**If fastening with adhesive**, follow the adhesive manufacturer's application instructions printed on the adhesive container.

**If installing with the optional hardware**, contact Nixalite® for details on installing the bird spike mounting hardware and accessories.

**Make sure all spike strips are securely fastened to the installation surfaces.**

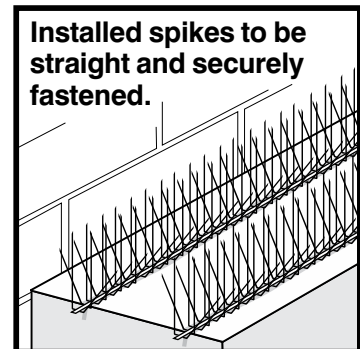
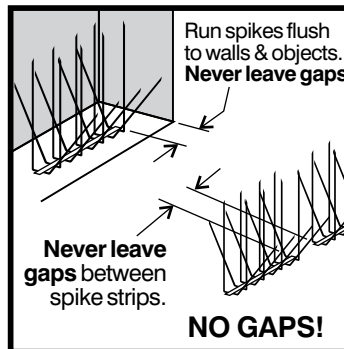
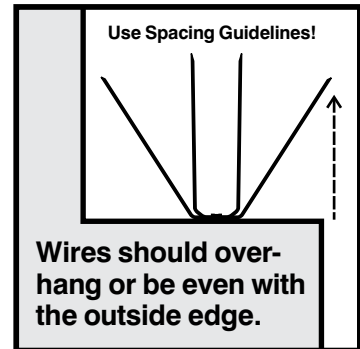
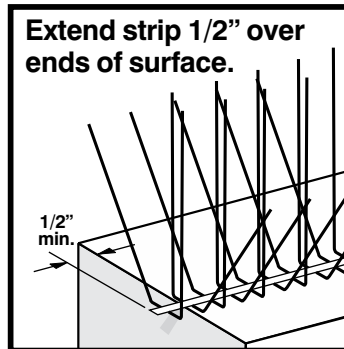

**Nixalite® of America Inc**  
 1025 16th Avenue, East Moline, IL. 61244  
 Experts In Architectural Bird Control Since 1950

**Phone:** 800.624.1189 or 309.755.8771  
**Fax:** 800.624.1196 or 309.755.0077  
**Email:** birdcontrol@nixalite.com  
**Web:** www.nixalite.com